

Creo Dynamics

Aerospace SE-UK Meeting

Vinnova

2018-09-07

Magnus Titus

Creo Dynamics – Three Core Competencies

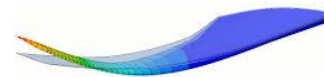
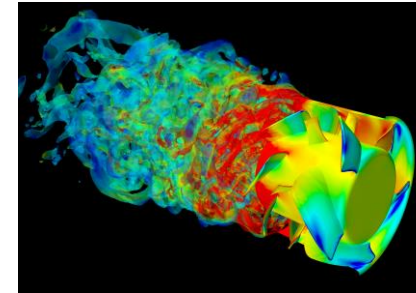
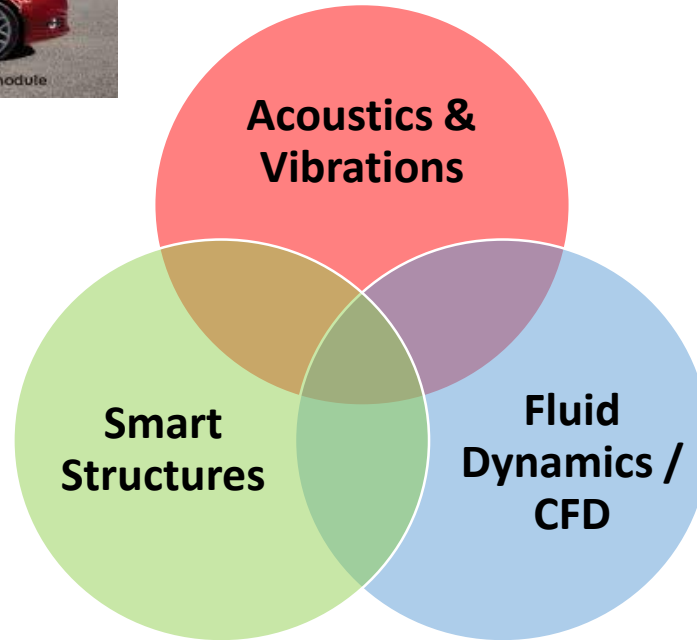
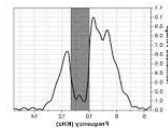
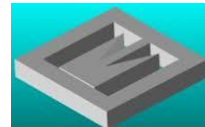
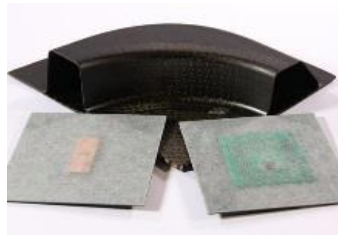

Expert Consulting + Innovation + Research

Creo Dynamics – Global – Some examples of Partners and Clients

COMBITECH

Ultra
ELECTRONICS

Arcam
A GE Additive Company

SIEMENS

VÄDERSTAD



Atlas Copco



CEVT

THULE
SWEDEN

NEVS



Together
ahead. RUAG



GEELY

Ferrari

CHANGAN

AIRBUS

BAE SYSTEMS

MAGNA

Tetra Pak



faurecia
inspiring mobility



GTT
SYSTEMS

Altair



CAR-O-LINER

ABB

HIAK
CUSTOMIZED NOISE REDUCTION

DEKRA

CREO
DYNAMICS

SE-UK Aerospace Initiative – Creo Dynamics' Proposals

Acousto-Ultrasonic Tomography

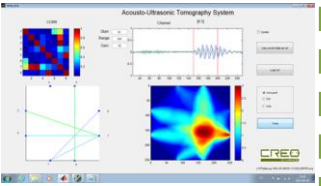
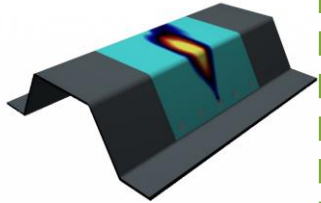

Acousto-Ultrasonic Tomography - NDT defect detection in composite structures

Concept developed within the Locomachs program

TRL4 = Proof-of-concept as well as Demonstrator in place

Next step:

Industrialization of the concept for applications within Aerospace composite materials production – Robust, easy-to-use method

Metamaterial Liner

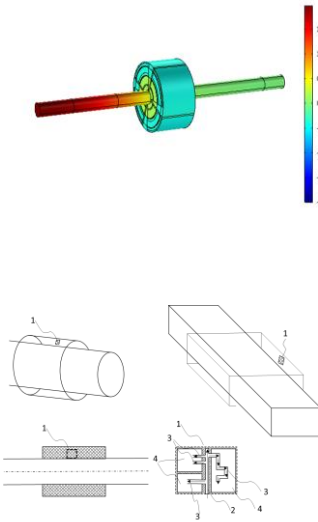

Metamaterial Liner – An Innovative concept for low profile dampening liners

Innovated by Creo Dynamics

Can be applied on heat resistant liner from the Clean Sky Hostel program – Take it to a new level of noise reduction!

On-going development for Automotive applications within the ECO2 program – HVAC, exhaust etc..

Next step:

Develop a Proof of Concept / Demonstrator for aerospace liner applications



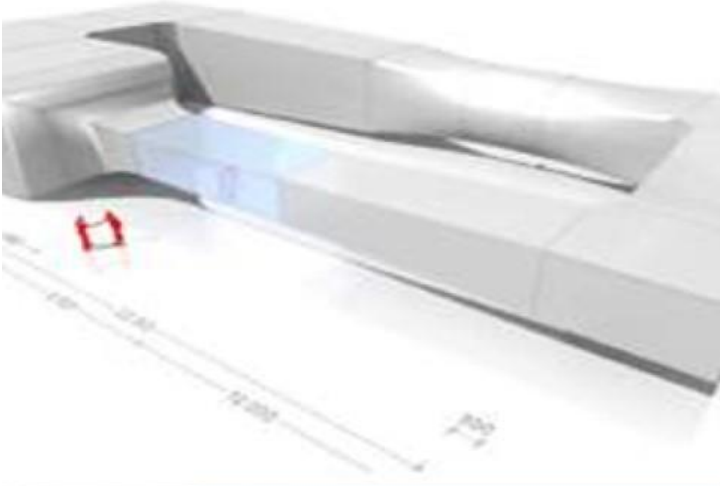
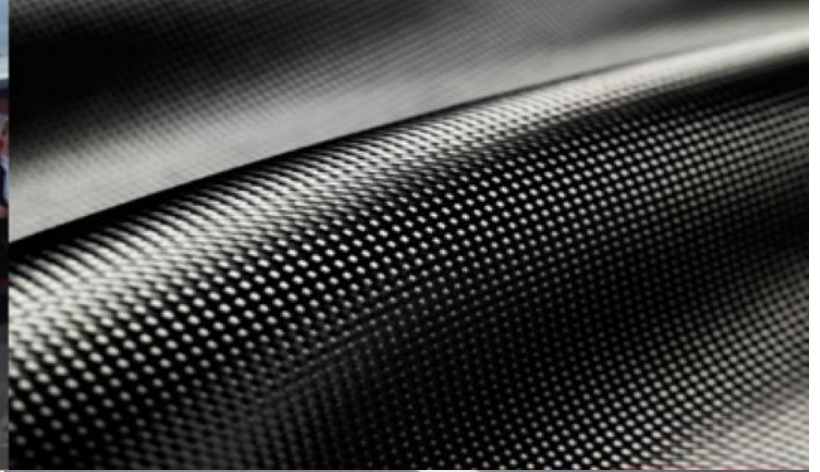

Creo Dynamics | Pioneering Solutions

Linköping	Lund	Göteborg	Stockholm
Westmansgatan 37A	IDEON Gateway	Kvarnbergsgatan 2	Vasavägen 52
SE-582 16 Linköping	Sheelevägen 27	SE-411 05 Göteborg	SE-111 20 Stockholm
Sweden	SE-223 63 Lund	Sweden	Sweden
	Sweden		

